

cc-by-sa Émilie Gillet emilie.o.gillet@gmail.com	⊗ ⊗ ⊗ ⊗	Digital section
		tides_v40
		02/04/2019 22:05
		Sheet: 1/3

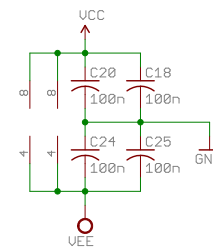

cc-by-sa
 Émilie Gillet
 emilie.o.gillet@gmail.com

Analog Section
 tides_v40
 02/04/2019 22:05
 Sheet: 2/3

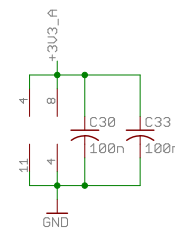
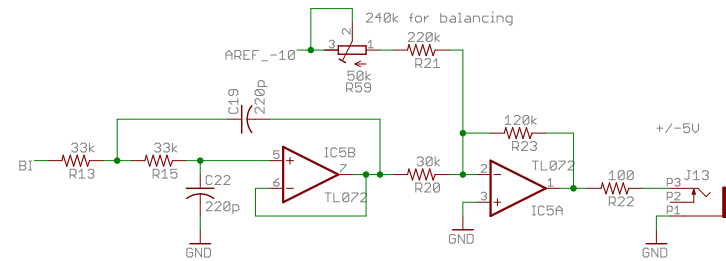
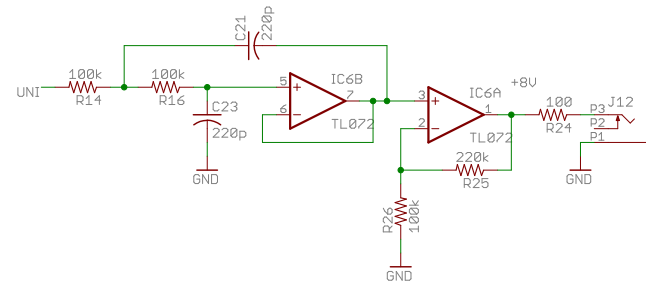
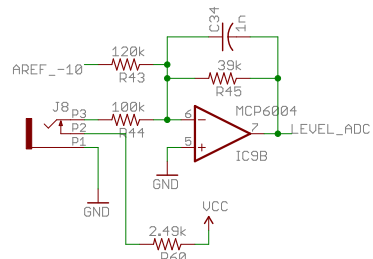
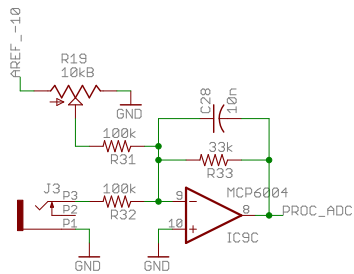
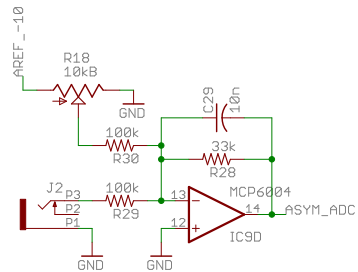
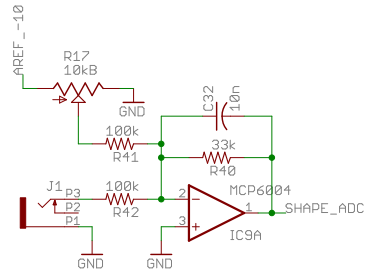
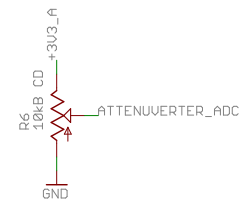
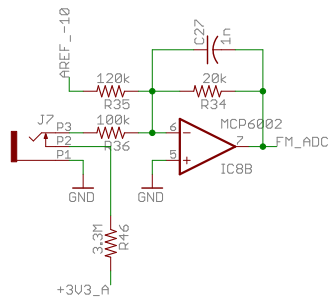
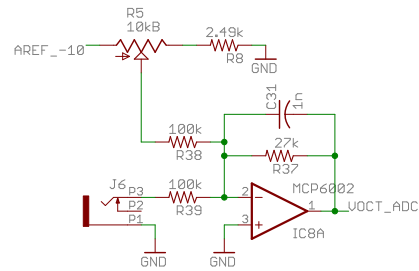
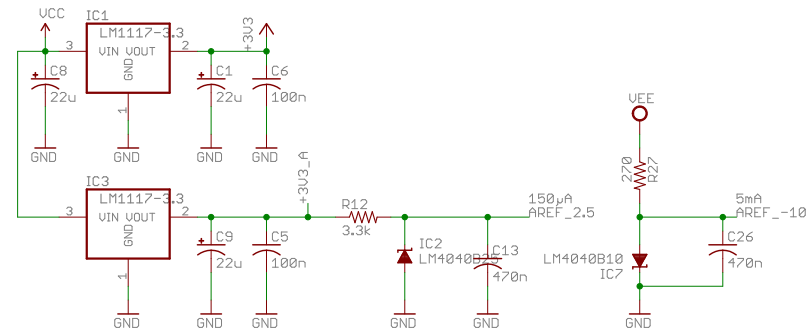
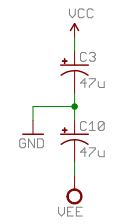
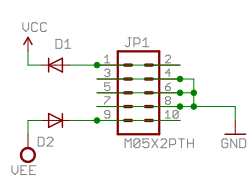

cc-by-sa	Power supply
Émilie Gillet	tides_v40
emilie.o.gillet@gmail.com	02/04/2019 22:05
	Sheet: 3/3